

PRODUCT AND STOCK ADVANTAGES

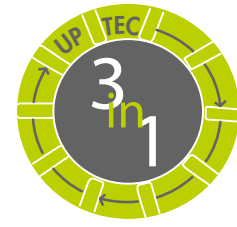

Full system with only 3 SKUs



The system is in compliance with the EPD regulation (Environmental product declaration)

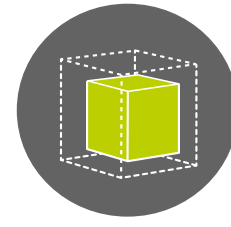

Optimizing inventory space management and investment and easy management on site

FLEXIBLE HEIGHT

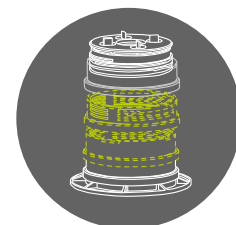

Simply add SUPAR ring to increase pedestal height

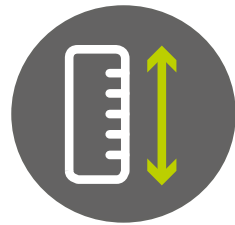

Height adjustable pedestal

FIXED OR SELF-LEVELING HEAD



Self-leveling head to reach up to 5% slope

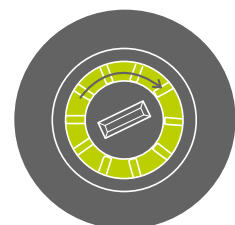

Simple switch mechanism between fixed and self-leveling mode

HEADS ADVANTAGES



Switch heads for standard installation or for wood or aluminium joists



Heads with sound dampening rubber

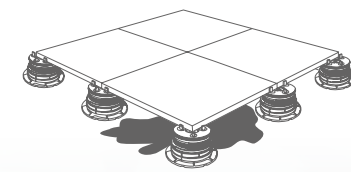

Quick water drainage

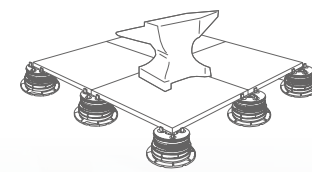

Exceptional load bearing strength



positive profile

Profilitec S.p.A.

Via Scotte, 3  
36033 Isola Vicentina  
(Vicenza) Italy



profilitec@profilitec.com



+39 0444 268311

Profilitec Corp.

472 Meeting Street  
Suite C - #301  
Charleston, SC 29403, USA

customerservice@profilitec.com

Toll free number: 855 290 9591

www.profilitec.com



8 014055 123630

July 2021 | Profilitec reserves the right to change or revise without notice any information given in this publication



up+tec®

EN/US



up+tec 3in1 is a series of universal adjustable pedestals for raised floors applications. 3 items (SUPAL, SUPAS and SUPAR) in one system. The 3 core products are complemented by 3 accessories SUPA2 for 3/32" joint (2mm), SUPA4 for 5/32" joint (4mm) and SUPAW (for wooden beams to go with decking).



SUPAS  
Standard pedestal



SUPAR  
Modular ring



SUPAL  
Low pedestal

up+tec - 3 ACCESSORIES

SUPA2



Tab - 2 mm - 3/32"

SUPA4



Tab - 4 mm - 5/32"

SUPAW



Head for wood joists

RAISED FLOOR ADVANTAGES

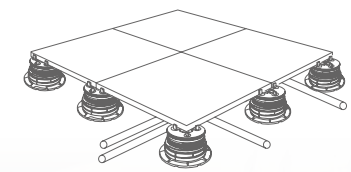

Excellent access to hidden pipes and equipment

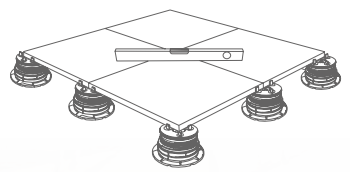

Always flat surfaces and easily accessible

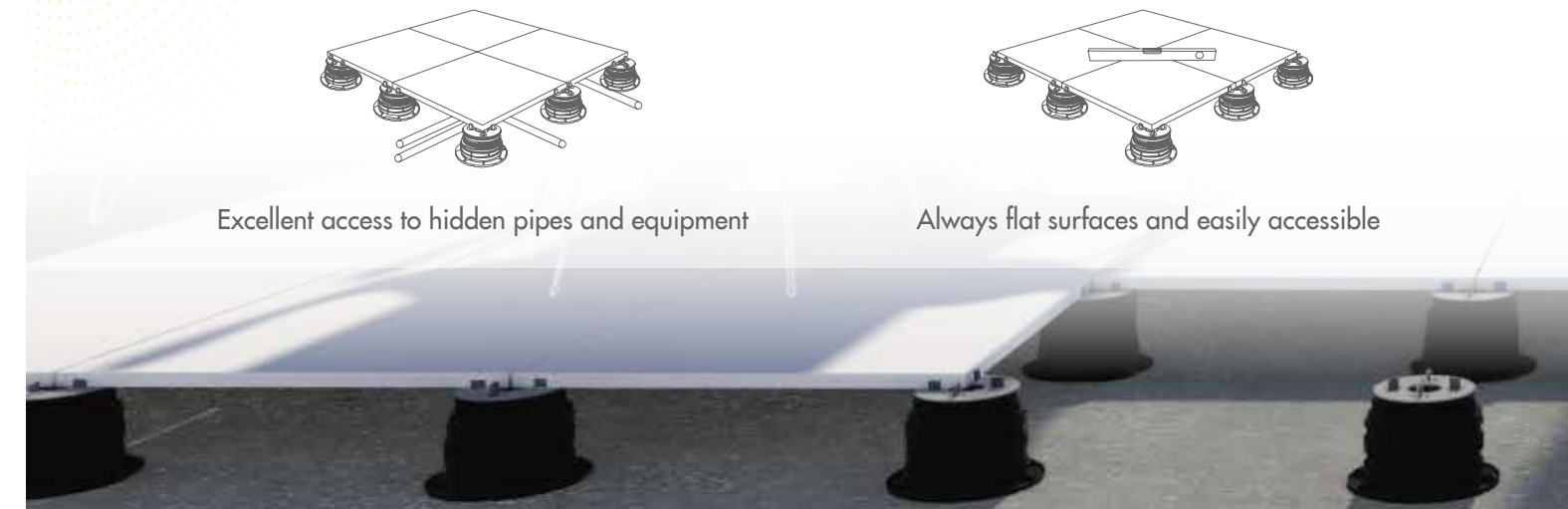

# up+tec - Installation

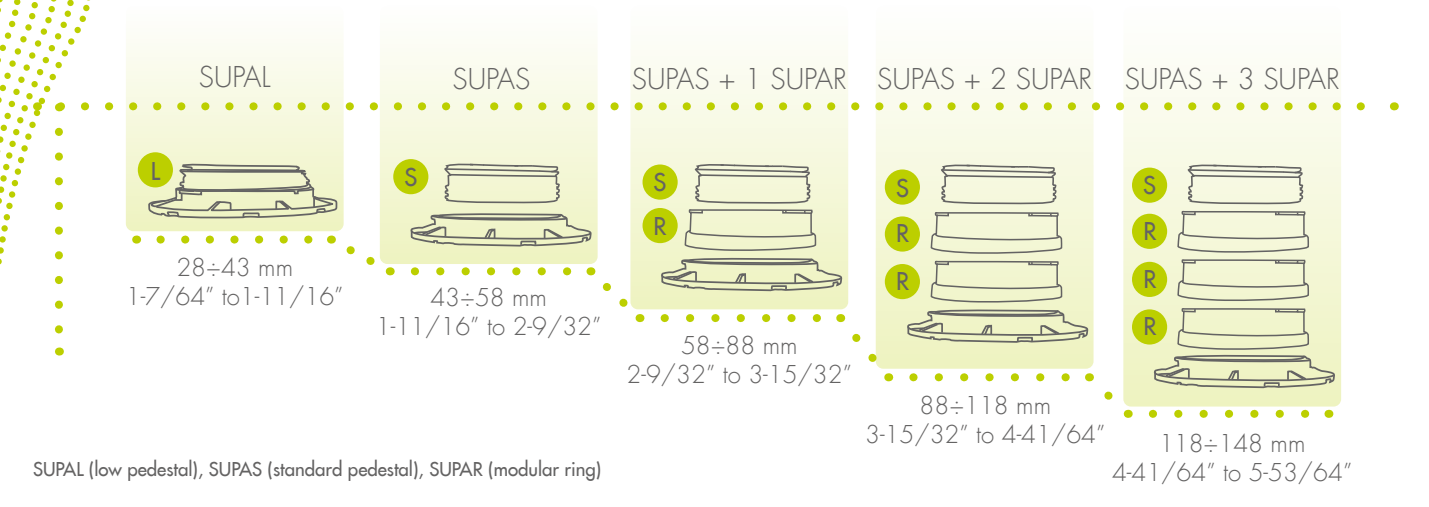

## up+tec ASSEMBLY (Example SUPAS + 1 SUPAR)



## up+tec HEAD ASSEMBLY



### 3 FUNCTIONS KEY



For more information on Uptec, visit [www.profilitec.com](http://www.profilitec.com) or contact customer service.

# up+tec - System components

**SUPAAN**  
Aluminum joists for SUPA4

**SUPG**  
Sound dampening rubber for SUPAAN

**SUPD**  
Tile spacer to be used with SUPAAN

**SUPCLIP**  
Perimeter and central clips to be used with decking and in combination with SUPAAN

**SUPAJ**  
Joist junction

**SUPATG**  
Mat to protect the substrate

# up+tec - System components

**BSJ**  
Profile for raised floor for 3/4" (2 cm) tiles

**BSR**  
Profile for raised floor

**BST**  
Profile for raised floor

**SUPACLPB**  
Clip for perimeter - Base to hold 3/4" (2 cm) tiles

**SUPACLPT**  
Clip for perimeter - Head to hold 3/4" (2 cm) tiles

**SUPCLPP**  
Perimeter tile spacer

**SUPL2 - SUPL3**  
Leveling disk 3/32" (2 mm) and 1/8" (3 mm)

**SUPAR120**  
Modular ring of 120 mm - 4-3/4" height

# up+tec ground

up+tec ground is a series of pedestals to be used with raised floors of low height. Two models of adjustable pedestals from 3/8" (10 mm) to 9/16" (15 mm), SUPT for 3/32" (2 mm) or SUPT4 for 5/32" joints (4 mm joints). The height can be extended thanks to the stackable SUPB accessory 3/16" (+ 5 mm). (Max 3 SUPB) Height can be adjusted from the top of the pedestal.

